

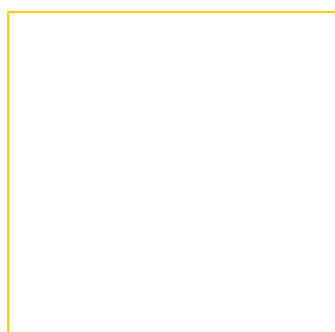

DORIN®

i n n o v a t i o n

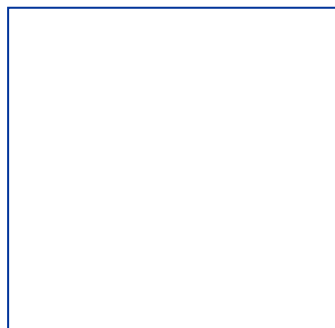
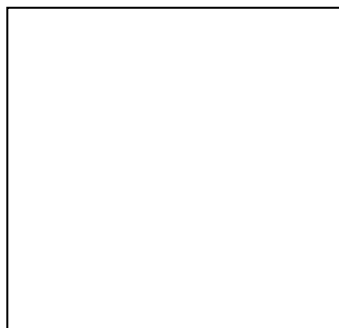
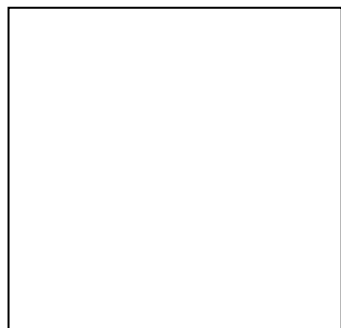
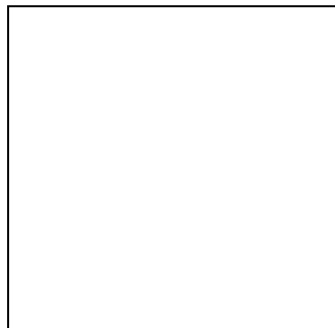
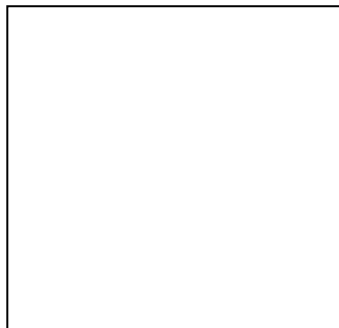
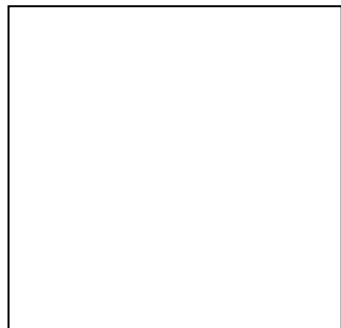

H

RANGE

2012



MOTOCOMPRESSORI SEMIERMETICI
SEMI-HERMETIC MOTOR-COMPRESSORS
MOTO-COMPRESSEURS SEMI-HERMETIQUES
HALBHERMETISCHE VERDICHTER

■	Introduzione / Introduction / Introduction / Einführung	3
■	Gamma completa / Complete range / Gamma complete / Produktpalette	4
■	Pesi e rubinetti / Weight and valves / Poids et vannes / Gewichte und Ventile	5
■	Caratteristiche tecniche / Technical data / Caractéristiques techniques / Technische Merkmale	6
	Max corrente di funzionamento / Max operating current / Max intensité de fonctionnement / Max Betriebsstrom	6
	Corrente a rotore bloccato / Locked rotor current / Courant a rotor bloqué / Anlaufstrom	8
■	Accessori / Accessories / Accessoires / Zubehör	10
■	Pressione sonora / Sound pressure / Pression acoustique / Schalldruckpegel	12
■	Limiti d'applicazione / Application limits / Champs d'application / Einsatzgrenzen	13
■	Prestazioni / Performances Data / Données de puissance / Leistungswerte	14
	R134a	14
	R404A / R507	19
	R407C	24
■	Ingombri / Overall dimensions / Encombremments / Abmessungen	27

H RANGE

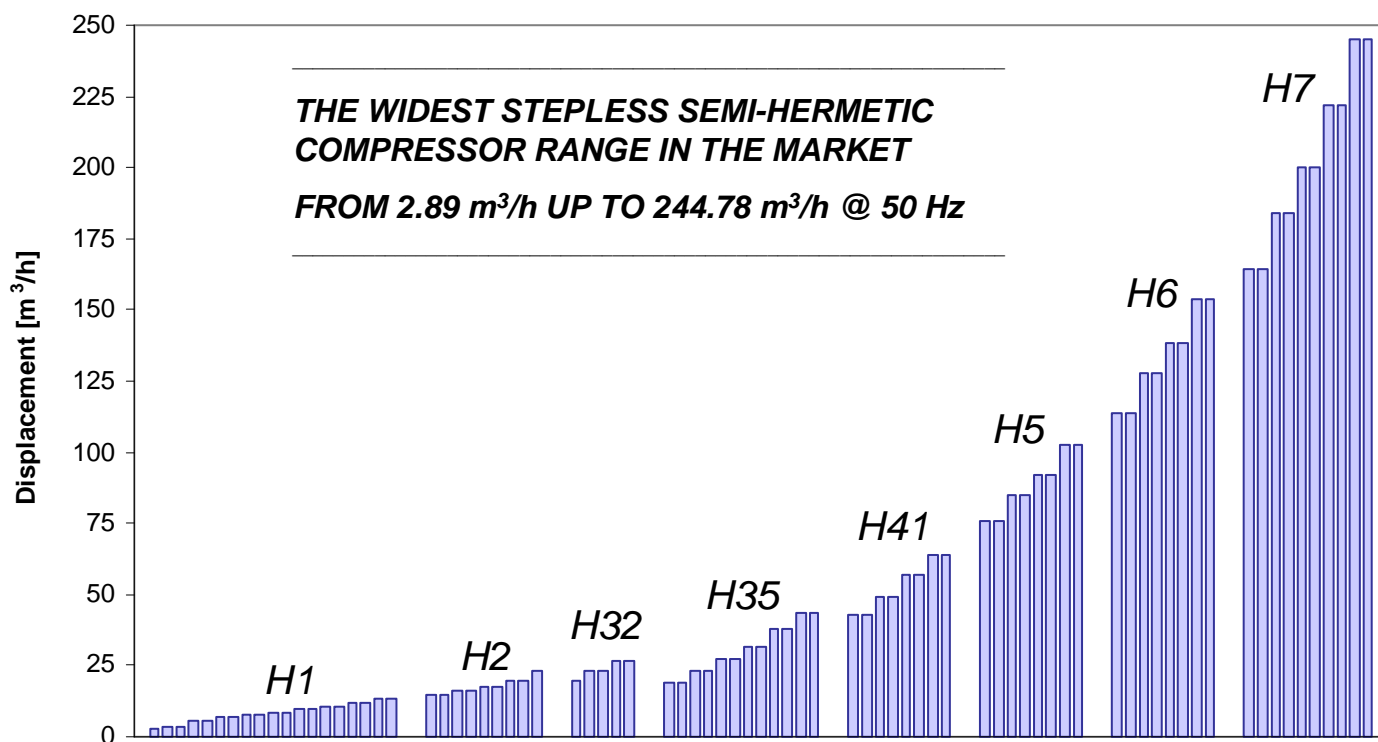

member of:



www.asercom.org

I compressori semiermetici Dorin nascono per essere la miglior risposta alle caratteristiche dei nuovi refrigeranti ed alle esigenze di mercato, ponendo in primo piano gli aspetti legati ad efficienza energetica, affidabilità e silenziosità.

La gamma copre volumi spostati da 2,89 a 244,78 m³/h, con potenze elettriche nominali da 0,5 a 90 hp.

Le principali caratteristiche della gamma presentata sono:

- elevati valori di C.O.P., ottenuti grazie all'ottimizzazione fluidodinamica dei passaggi interni, all'adozione di motori ad alta efficienza ed all'introduzione di componentistica di ultima generazione
- possibilità di funzionamento con tutti i refrigeranti più diffusi sul mercato: R404A, R134a, R407C, R507
- livelli di rumorosità estremamente contenuti
- fenomeni vibratorii limitati, tramite accurato bilanciamento delle masse
- riduzione delle pulsazioni di pressione del gas
- possibilità di azionamento a frequenza variabile
- scatola attacchi elettrici IP 65 di serie sulla totalità della gamma

La qualità dell'intera produzione Dorin è garantita dalla conformità alle norme EN ISO9001. A richiesta sono disponibili modelli certificati UL.

(Underwriters Laboratories Inc.: file n° SA11929).

Dorin semihermetic compressors are created to be even more compatible with the characteristics of new refrigerants and the demands of the market related to efficiency, reliability and low noise level.

The range covers displacements from 2,89 to 244,78 m³/h and nominal capacities from 0,5 to 90 hp.

The main characteristics of our compressors are:

- high C.O.P. values, thanks to fluidodynamic optimisation of the internal flow paths, high efficiency motors and high tech components
- suitable for all the main refrigerants available, e.g. R404A, R134a, R407C, R507
- very low noise level
- low vibrations, thanks to an optimised mass balance
- low gas pulsation
- available on request for frequency variations
- standard electrical box IP65

Dorin's manufacturing quality is granted by the certification provided in accordance with Directive EN ISO9001. On request, we are able to supply compressors complying with UL requirements.

(Underwriters Laboratories Inc.: file n° SA11929).

Les compresseurs semihermétiques Dorin sont créés pour être la meilleure réponse aux caractéristiques des nouveaux réfrigérants et aux exigences du marché, tenant compte en premier lieu des aspects d'efficacité énergétique, de fiabilité et de silence.

La gamme couvre des volumes balayés de 2,89 à 244,78 m³/h et des puissances nominales de 0,5 to 90 hp.

Les principales caractéristiques de la gamme présentée sont:

- C.O.P. élevés grâce à une optimisation fluidodynamique du circuit interne de compression, à moteurs électriques à haute efficacité et à des composants de dernière génération
- possibilité de fonctionnement avec les réfrigérants les plus utilisés sur le marché: R404A, R134a, R407C, R507
- niveaux sonores extrêmement bas
- réduction quasi totale des phénomènes de vibrations grâce à un équilibrage parfait des masses
- réduction des régimes pulsatoires
- possibilité d'utiliser des systèmes à fréquence variable
- boîtiers électriques IP 65 en série sur la quasi totalité de la gamme

Le processus interne de la démarche qualité est garantie par l'homologation à la norme EN ISO9001. Sur demande, sont disponibles des modèles certifiés UL.

(Underwriters Laboratories Inc.: file n° SA11929).

Die halbhermetischen Verdichter von Dorin wurden entwickelt um den Anforderungen der neuen Kältemittel und den Markterfordernissen Rechnung zu tragen, wobei die Aspekte Energieeffizienz, Zuverlässigkeit und minimale Geräuschentwicklung im Vordergrund standen.

Die Baureihe deckt Fördermengen von 2,89 bis 244,78 m³/h ab bei Nennleistungen zwischen 0,5 PS und 90 PS.

Wichtigste Merkmale der vorgestellten Baureihe:

- hohe Leistungszahl (COP) dank der Optimierung der Strömungsdynamik der internen Medienleitungen, der Verwendung von Hochleistungsmotoren und der Einführung von Komponenten der neuesten Generation
- Betrieb mit allen markt gängigen Kältemitteln möglich: R404A, R134a, R407C, R507
- Extrem geringe Geräuschentwicklung
- Verringerung von Schwingungen durch optimalen Massenausgleich
- Verringerung von Gasdruckschwankungen
- Ansteuerung mit unterschiedlichen Frequenzen möglich
- Schutzart IP 65 bei fast allen Modellen der Baureihe serienmäßig

Die Qualität aller Dorin-Produkte ist gewährleistet durch ein zertifiziertes Qualitätsmanagementsystem nach EN ISO 9001. Modelle mit UL-Zulassung sind auf Anfrage lieferbar.

(Underwriters Laboratories Inc.: file n° SA11929).

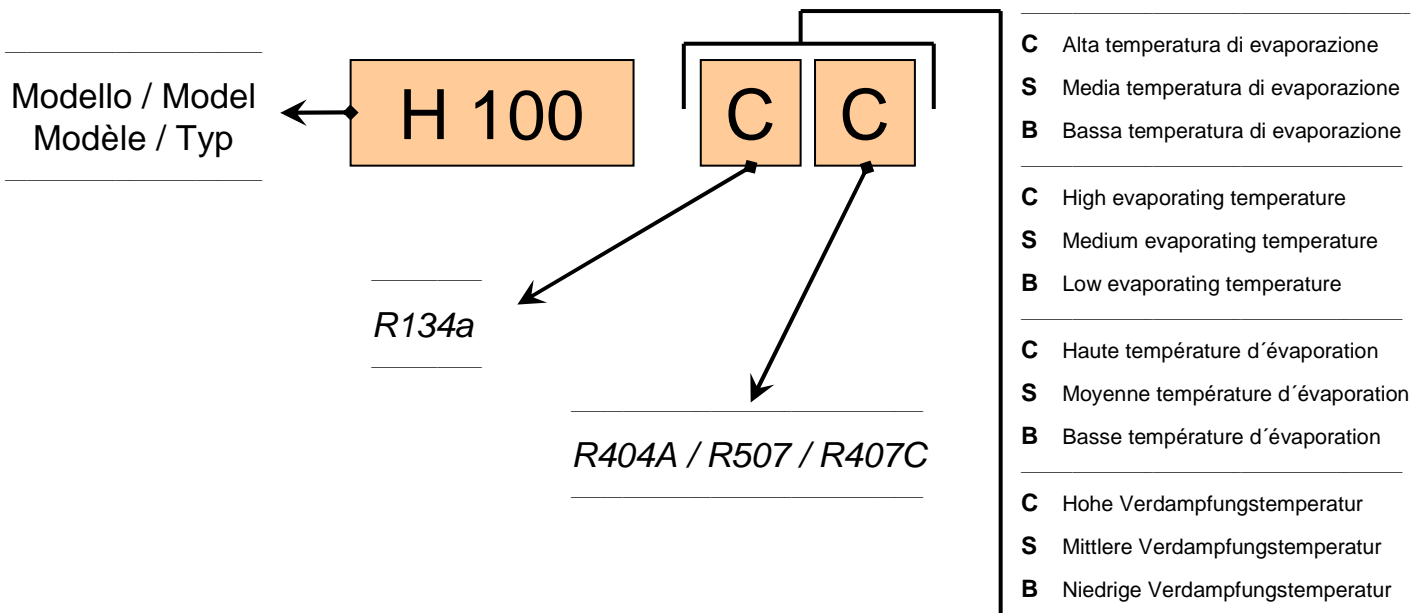

Serie Range Serie Serie	Modello Model Modèle Typ	Vol. Spost. Displacement Volume bal. Fördervolumen [m ³ /h]	Cilindri Cylinders Cylindres Zylinder	Campo d'applicazione Application range Champs d'application Einsatzbereich	
				R404A / R507 R407C *	R134a
H1	H40CC	2,89	2	H	H
	H50CS	3,86	2	M	H
	H75CC	3,86	2	H	H
	H75CS	5,30	2	M	H
	H100CC	5,30	2	H	H
	H100CS	6,75	2	M	H
	H150CC	6,75	2	H	H
	H150CS	7,71	2	M	H
	H180CC	7,71	2	H	H
	H180CS	8,47	2	M	H
	H200CC	8,47	2	H	H
	H200CS	9,88	2	M	H
	H220CC	9,88	2	H	H
	H220CS	10,85	2	M	H
	H250CC	10,85	2	H	H
	H250CS	12,17	2	M	H
H280CC	12,17	2	H	H	
H280SB	13,23	2	M	H	
H280CS	13,23	2	M	H	
H2	H290CS	14,74	2	M	H
	H300CC	14,74	2	H	H
	H300CS	15,94	2	M	H
	H350CC	15,94	2	H	H
	H350SB	17,53	2	L	H
	H380CC	17,53	2	H	H
	H380SB	19,53	2	L	H
	H390CS	19,53	2	M	H
	H392CS	23,31	2	L	H
H32	H403CC	19,98	2	H	H
	H403CS	22,83	2	M	H
	H503CC	22,83	2	H	H
	H503CS	26,44	2	M	H
	H743CC	26,44	2	H	H
H35	H401CS	19,29	4	M	H
	H451CC	19,29	4	H	H
	H451CS	23,13	4	M	H
	H551CC	23,13	4	H	H
	H551CS	27,33	4	M	H
	H701CC	27,33	4	H	H
	H701CS	31,88	4	M	H
	H751CC	31,88	4	H	H
	H751CS	38,06	4	M	H
	H801CC	38,06	4	H	H
	H801CS	43,73	4	M	H
H851CC	43,73	4	H	H	
H41	H851CS	42,81	4	M	H
	H1001CC	42,81	4	H	H
	H1001CS	48,82	4	M	H
	H1501CC	48,82	4	H	H
	H1501CS	56,87	4	M	H
	H2001CC	56,87	4	H	H
	H1601CS	63,76	4	M	H
H2201CC	63,76	4	H	H	

Serie Range Serie Serie	Modello Model Modèle Typ	Vol. Spost. Displacement Volume bal. Fördervolumen [m ³ /h]	Cilindri Cylinders Cylindres Zylinder	Campo d'applicazione Application range Champs d'application Einsatzbereich	
				R404A / R507 R407C*	R134a
H5	H2000CS	75,83	4	M	H
	H2500CC	75,83	4	H	H
	H2500CS	85,01	4	M	H
	H3000CC	85,01	4	H	H
	H2700CS	92,25	4	M	H
	H3200CC	92,25	4	H	H
	H2900CS	102,35	4	M	H
	H3400CC	102,35	4	H	H
H6	H3000CS	113,74	6	M	H
	H3500CC	113,74	6	H	H
	H3500CS	127,52	6	M	H
	H4000CC	127,52	6	H	H
	H4000CS	138,37	6	M	H
	H4500CC	138,37	6	H	H
	H4500CS	153,52	6	M	H
	H5000CC	153,52	6	H	H
H7	H5000CS	164,30	8	M	H
	H5500CC	164,30	8	H	H
	H5500CS	184,19	8	M	H
	H6000CC	184,19	8	H	H
	H6000CS	199,86	8	M	H
	H7500CC	199,86	8	H	H
	H7501CS	221,75	8	M	H
	H8001CC	221,75	8	H	H
	H8000CS	244,78	8	M	H
H9000CC	244,78	8	H	H	

H Alta temperatura di evaporazione fino a +5 °C/+10 °C

M Media temperatura di evaporazione fino a -5 °C

L Bassa temperatura di evaporazione fino a -20 °C

H High evaporating temperature up to +5 °C/+10 °C

M Medium evaporating temperature up to -5 °C

L Low evaporating temperature up to -20 °C

H Haute température d'évaporation jusqu'à +5 °C/+10 °C

M Moyenne température d'évaporation jusqu'à -5 °C

L Basse température d'évaporation jusqu'à -20 °C

H Hohe Verdampfungstemperatur bis zu +5 °C/+10 °C

M Mittlere Verdampfungstemperatur bis -5 °C

L Niedrige Verdampfungstemperatur bis -20 °C

* Solo per modelli "CC" / "CC" models only / Uniquement modèles "CC" / Nur "CC" Modelle

Serie Range Serie Serie	Modello Model Modèle Typ	Carica olio Oil charge Charge huile Öfüllung	Aspirazione Suction Aspiration Saugventil	Scarico Discharge Refolement Druckventil	Peso netto Net weight Poids net Nettogewicht
		[kg]	SL [mm]	DL [mm]	[kg]
H1	H40CC	1,0	12s	12s	35
	H50CS	1,0	12s	12s	35
	H75CC	1,0	12s	12s	36
	H75CS	1,0	16s	12s	36
	H100CC	1,0	16s	12s	37
	H100CS	1,0	16s	12s	37
	H150CC	1,0	16s	12s	38
	H150CS	1,0	16s	12s	38
	H180CC	1,0	16s	12s	39
	H180CS	1,0	16s	12s	39
	H200CC	1,0	16s	12s	40
	H200CS	1,0	18s	16s	40
	H220CC	1,0	18s	16s	41
	H220CS	1,0	18s	16s	41
	H250CC	1,0	18s	16s	41
	H250CS	1,0	18s	16s	41
	H280CC	1,0	18s	16s	43
	H280SB	1,0	18s	16s	44
	H280CS	1,0	18s	16s	44
	H2	H290CS	1,4	22s	16s
H300CC		1,4	22s	16s	54
H300CS		1,4	28s	16s	54
H350CC		1,4	28s	16s	54
H350SB		1,4	28s	16s	54
H380CC		1,4	28s	16s	56
H380SB		1,4	28s	16s	56
H390CS		1,4	28s	16s	56
H392CS		1,4	28s	16s	56
H32	H403CC	2,0	28s	16s	75
	H403CS	2,0	28s	16s	76
	H503CC	2,0	28s	16s	79
	H503CS	2,0	35s	16s	80
	H743CC	2,0	35s	16s	81
H35	H401CS	2,0	22s	18s	89
	H451CC	2,0	22s	18s	91
	H451CS	2,0	28s	18s	89
	H551CC	2,0	28s	18s	91
	H551CS	2,0	28s	22s	91
	H701CC	2,0	28s	22s	91
	H701CS	2,0	28s	22s	91
	H751CC	2,0	28s	22s	91
	H751CS	2,0	35s	22s	91
	H801CC	2,0	35s	22s	101
H801CS	2,0	35s	22s	91	
H851CC	2,0	35s	22s	101	
H41	H851CS	2,5	35s	28s	125
	H1001CC	2,5	35s	28s	130
	H1001CS	2,5	35s	28s	127
	H1501CC	2,5	42s	28s	131
	H1501CS	2,5	35s	28s	127
	H2001CC	2,5	42s	28s	131
	H1601CS	2,5	42s	28s	134
H2201CC	2,5	42s	28s	136	

Serie Range Serie Serie	Modello Model Modèle Typ	Carica olio Oil charge Charge huile Öfüllung	Aspirazione Suction Aspiration Saugventil	Scarico Discharge Refolement Druckventil	Peso netto Net weight Poids net Nettogewicht
		[kg]	SL [mm]	DL [mm]	[kg]
H5	H2000CS	3,5	42s	28s	190
	H2500CC	3,5	54s	28s	185
	H2500CS	3,5	54s	28s	185
	H3000CC	3,5	54s	28s	199
	H2700CS	3,5	54s	35s	200
	H3200CC	3,5	54s	35s	205
	H2900CS	3,5	54s	35s	205
	H3400CC	3,5	54s	35s	205
H6	H3000CS	3,5	54s	35s	235
	H3500CC	3,5	54s	35s	246
	H3500CS	3,5	54s	35s	233
	H4000CC	3,5	54s	35s	249
	H4000CS	3,5	54s	42s	244
	H4500CC	3,5	54s	42s	252
	H4500CS	3,5	54s	42s	253
	H5000CC	3,5	54s	42s	253
H7	H5000CS	8,5	66s	42s	350
	H5500CC	8,5	66s	42s	355
	H5500CS	8,5	80s	42s	350
	H6000CC	8,5	80s	42s	355
	H6000CS	8,5	80s	42s	355
	H7500CC	8,5	80s	42s	357
	H7501CS	8,5	80s	54s	355
	H8001CC	8,5	80s	54s	357
	H8000CS	8,5	80s	54s	360
H9000CC	8,5	80s	54s	366	

Serie Range Serie Serie	Modello Model Modèle Typ	Vol. Spost. Displacement Volume bal. Fördervolumen		Max corrente di funzionamento / Max operating current Max intensité de fonctionnement / Max Betriebsstrom V / ph / Hz [A]												
		50 Hz [m³/h]	60 Hz [m³/h]	220-240 / 1 / 50	208-230 / 1 / 60	115 / 1 / 60	220-240 / 3 / 50 265-290 / 3 / 60 Δ	380-420 / 3 / 50 440-480 / 3 / 60 Y	208-230 / 3 / 60 Δ	360-400 / 3 / 60 Y	200 / 3 / 50-60 Δ	380-420 / 3 / 50 440-480 / 3 / 60 PWS	220-240 / 3 / 50 PWS	208-230 / 3 / 60 PWS	360-400 / 3 / 60 PWS	500-550 / 3 / 50
H41	H851CS	42,81	51,38	-	-	-	33,0	19,1	39,6	22,9	-	19,1	33,0	39,6	22,9	14,5
	H1001CC	42,81	51,38	-	-	-	43,3	25,0	51,9	30,0	-	25,0	43,3	51,9	30,0	19,0
	H1001CS	48,82	58,58	-	-	-	38,1	22,0	45,7	26,4	-	22,0	38,1	45,7	26,4	16,8
	H1501CC	48,82	58,58	-	-	-	58,8	34,0	70,6	40,8	-	34,0	58,8	70,6	40,8	25,9
	H1501CS	56,87	68,25	-	-	-	43,3	25,0	51,9	30,0	-	25,0	43,3	51,9	30,0	19,0
	H2001CC	56,87	68,25	-	-	-	65,7	38,0	78,9	45,6	-	38,0	65,7	78,9	45,6	29,0
	H1601CS	63,76	76,51	-	-	-	58,8	34,0	70,6	40,8	-	34,0	58,8	70,6	40,8	25,9
	H2201CC	63,76	76,51	-	-	-	77,9	45,0	93,4	54,0	-	45,0	77,9	93,4	54,0	34,3
H5	H2000CS	75,83	91,00	-	-	-	65,7	38,0	78,9	45,6	-	38,0	65,7	78,9	45,6	-
	H2500CC	75,83	91,00	-	-	-	83,0	48,0	99,6	57,6	-	48,0	83,0	99,6	57,6	-
	H2500CS	85,01	102,02	-	-	-	77,9	45,0	93,4	54,0	-	45,0	77,9	93,4	54,0	-
	H3000CC	85,01	102,02	-	-	-	96,9	56,0	116,3	67,2	-	56,0	96,9	116,3	67,2	-
	H2700CS	92,25	110,69	-	-	-	83,0	48,0	99,6	57,6	-	48,0	83,0	99,6	57,6	-
	H3200CC	92,25	110,69	-	-	-	103,8	60,0	124,6	72,0	-	60,0	103,8	124,6	72,0	-
	H2900CS	102,35	122,82	-	-	-	96,9	56,0	116,3	67,2	-	56,0	96,9	116,3	67,2	-
	H3400CC	102,35	122,82	-	-	-	103,8	60,0	124,6	72,0	-	60,0	103,8	124,6	72,0	-
H6	H3000CS	113,74	136,49	-	-	-	96,9	56,0	116,3	67,2	-	56,0	96,9	116,3	67,2	-
	H3500CC	113,74	136,49	-	-	-	103,8	60,0	124,6	72,0	-	60,0	103,8	124,6	72,0	-
	H3500CS	127,52	153,02	-	-	-	96,9	56,0	116,3	67,2	-	56,0	96,9	116,3	67,2	-
	H4000CC	127,52	153,02	-	-	-	124,6	72,0	149,5	86,4	-	72,0	124,6	149,5	86,4	-
	H4000CS	138,37	166,04	-	-	-	103,8	60,0	124,6	72,0	-	60,0	103,8	124,6	72,0	-
	H4500CC	138,37	166,04	-	-	-	145,3	84,0	174,4	100,8	-	84,0	145,3	174,4	100,8	-
	H4500CS	153,52	184,22	-	-	-	124,6	72,0	149,5	86,4	-	72,0	124,6	149,5	86,4	-
	H5000CC	153,52	184,22	-	-	-	160,9	93,0	193,1	111,6	-	93,0	160,9	193,1	111,6	-
H7	H5000CS	164,30	197,16	-	-	-	155,7	90,0	186,8	108,0	-	90,0	155,7	186,8	108,0	-
	H5500CC	164,30	197,16	-	-	-	207,6	120,0	249,1	144,0	-	105,0	207,6	249,1	144,0	-
	H5500CS	184,19	221,03	-	-	-	155,7	90,0	186,8	108,0	-	105,0	155,7	186,8	108,0	-
	H6000CC	184,19	221,03	-	-	-	207,6	120,0	249,1	144,0	-	120,0	207,6	249,1	144,0	-
	H6000CS	199,86	239,83	-	-	-	207,6	120,0	249,1	144,0	-	105,0	207,6	249,1	144,0	-
	H7500CC	199,86	239,83	-	-	-	256,0	148,0	307,2	177,6	-	148,0	256,0	307,2	177,6	-
	H7501CS	221,75	266,10	-	-	-	207,6	120,0	249,1	144,0	-	120,0	207,6	249,1	144,0	-
	H8001CC	221,75	266,10	-	-	-	256,0	148,0	307,2	177,6	-	148,0	256,0	307,2	177,6	-
	H8000CS	244,78	293,74	-	-	-	207,6	120,0	249,1	144,0	-	120,0	207,6	249,1	144,0	-
	H9000CC	244,78	293,74	-	-	-	276,8	160,0	332,2	192,0	-	148,0	276,8	332,2	192,0	-

- Versione del motore standard. Per condizioni di funzionamento non indicate contattare il nostro servizio tecnico.
- Standard motor version. For operating conditions not indicated please contact our technical service.
- Standard version du moteur. Pour les conditions de fonctionnement pas indiquées contacter notre service technique.
- Standard Motor Version. Für Betriebsbedingungen, die hier nicht aufgeführt sind wenden Sie sich bitte an unseren Technischen Dienst.

Serie Range Serie Serie	Modello Model Modèle Typ	Vol. Spost. Displacement Volume bal. Fördervolumen		Corrente a rotore bloccato / Locked rotor current / Courant a rotor bloqué / Anlaufstrom V / ph / Hz [A]												
		50 Hz [m³/h]	60 Hz [m³/h]	220-240 / 1 / 50	208-230 / 1 / 60	115 / 1 / 60	220-240 / 3 / 50 265-290 / 3 / 60 Δ	380-420 / 3 / 50 440-480 / 3 / 60 Y	208-230 / 3 / 60 Δ	360-400 / 3 / 60 Y	200 / 3 / 50-60 Δ	380-420 / 3 / 50 440-480 / 3 / 60 PWS *	220-240 / 3 / 50 PWS *	208-230 / 3 / 60 PWS *	360-400 / 3 / 60 PWS *	500-550 / 3 / 50
H41	H851CS	42,81	51,38	-	-	-	181,0	104,6	217,2	125,5	-	104,6	181,0	217,2	125,5	79,7
	H1001CC	42,81	51,38	-	-	-	233,0	134,7	279,6	161,6	-	134,7	233,0	279,6	161,6	102,6
	H1001CS	48,82	58,58	-	-	-	188,0	108,7	225,6	130,4	-	108,7	188,0	225,6	130,4	82,8
	H1501CC	48,82	58,58	-	-	-	295,0	170,5	354,0	204,6	-	170,5	295,0	354,0	204,6	129,9
	H1501CS	56,87	68,25	-	-	-	233,0	134,7	279,6	161,6	-	134,7	233,0	279,6	161,6	102,6
	H2001CC	56,87	68,25	-	-	-	306,2	177,0	367,5	212,4	-	177,0	306,2	367,5	212,4	134,8
	H1601CS	63,76	76,51	-	-	-	295,0	170,5	354,0	204,6	-	170,5	295,0	354,0	204,6	129,9
H2201CC	63,76	76,51	-	-	-	351,2	203,0	421,4	243,6	-	203,0	351,2	421,4	243,6	155,0	
H5	H2000CS	75,83	91,00	-	-	-	306,2	177,0	367,5	212,4	-	177,0	306,2	367,5	212,4	-
	H2500CC	75,83	91,00	-	-	-	351,2	203,0	421,4	243,6	-	203,0	351,2	421,4	243,6	-
	H2500CS	85,01	102,02	-	-	-	351,2	203,0	421,4	243,6	-	203,0	351,2	421,4	243,6	-
	H3000CC	85,01	102,02	-	-	-	387,5	224,0	465,0	268,8	-	224,0	387,5	465,0	268,8	-
	H2700CS	92,25	110,69	-	-	-	351,2	203,0	421,4	243,6	-	203,0	351,2	421,4	243,6	-
	H3200CC	92,25	110,69	-	-	-	449,8	260,0	539,8	312,0	-	260,0	449,8	539,8	312,0	-
	H2900CS	102,35	122,82	-	-	-	387,5	224,0	465,0	268,8	-	224,0	387,5	465,0	268,8	-
H3400CC	102,35	122,82	-	-	-	449,8	260,0	539,8	312,0	-	260,0	449,8	539,8	312,0	-	
H6	H3000CS	113,74	136,49	-	-	-	387,5	224,0	465,0	268,8	-	224,0	387,5	465,0	268,8	-
	H3500CC	113,74	136,49	-	-	-	449,8	260,0	539,8	312,0	-	260,0	449,8	539,8	312,0	-
	H3500CS	127,52	153,02	-	-	-	387,5	224,0	465,0	268,8	-	224,0	387,5	465,0	268,8	-
	H4000CC	127,52	153,02	-	-	-	501,7	290,0	602,0	348,0	-	290,0	501,7	602,0	348,0	-
	H4000CS	138,37	166,04	-	-	-	449,8	260,0	539,8	312,0	-	260,0	449,8	539,8	312,0	-
	H4500CC	138,37	166,04	-	-	-	558,8	323,0	670,5	387,6	-	323,0	558,8	670,5	387,6	-
	H4500CS	153,52	184,22	-	-	-	501,7	290,0	602,0	348,0	-	290,0	501,7	602,0	348,0	-
H5000CC	153,52	184,22	-	-	-	619,3	358,0	743,2	429,6	-	358,0	619,3	743,2	429,6	-	
H7	H5000CS	164,30	197,16	-	-	-	683,4	395,0	820,0	474,0	-	367,0	683,4	820,0	474,0	-
	H5500CC	164,30	197,16	-	-	-	804,5	465,0	965,3	558,0	-	455,0	804,5	965,3	558,0	-
	H5500CS	184,19	221,03	-	-	-	683,4	395,0	820,0	474,0	-	455,0	683,4	820,0	474,0	-
	H6000CC	184,19	221,03	-	-	-	804,5	465,0	965,3	558,0	-	544,0	804,5	965,3	558,0	-
	H6000CS	199,86	239,83	-	-	-	804,5	465,0	965,3	558,0	-	455,0	804,5	965,3	558,0	-
	H7500CC	199,86	239,83	-	-	-	1086,4	628,0	1303,7	753,6	-	584,0	1086,4	1303,7	753,6	-
	H7501CS	221,75	266,10	-	-	-	804,5	465,0	965,3	558,0	-	544,0	804,5	965,3	558,0	-
	H8001CC	221,75	266,10	-	-	-	1086,4	628,0	1303,7	753,6	-	584,0	1086,4	1303,7	753,6	-
	H8000CS	244,78	293,74	-	-	-	804,5	465,0	965,3	558,0	-	544,0	804,5	965,3	558,0	-
	H9000CC	244,78	293,74	-	-	-	1086,4	628,0	1303,7	753,6	-	584,0	1086,4	1303,7	753,6	-

Versione del motore standard. Per condizioni di funzionamento non indicate contattare il nostro servizio tecnico.

* Il valore di corrente indicato si riferisce al collegamento diretto. Per ottenere il valore con collegamento PWS consultare il bollettino tecnico.

Standard motor version. For operating conditions not indicated please contact our technical service.

* The current value indicated refers to the direct connection. For the value with PWS connecting see technical bulletin.

Standard version du moteur. Pour les conditions de fonctionnement pas indiquées contacter notre service technique.

* La valeur de courant indiqué se réfère à la connexion directe. Pour obtenir la valeur avec connexions PWS voir le Bulletin technique.

Standard Motor Version. Für Betriebsbedingungen, die hier nicht aufgeführt sind wenden Sie sich bitte an unseren Technischen Dienst.

* Der angegebene Wert bezieht sich auf direkten Anschluss. Um den Wert der PWS-Verbindung siehe Technical Bulletin.

Serie Range Serie Serie	Modello Model Modèle Typ	Vol. Spost. Displacement Volume bal. Fördervolumen		Pressione sonora / Sound pressure (free field) Pression acoustique / Schalldruckpegel						Potenza sonora / Sound power Puissance acoustique / Schalleistung				
		50 Hz	60 Hz	1,8 m			5 m			ISO9614-1 grade 2				
				Te / Tc [°C]			Te / Tc [°C]			Te / Tc [°C]				
		[m³/h]		+7 / +50	-10 / +45	-30 / +40	+7 / +50	-10 / +45	-30 / +40	+7 / +50	-10 / +45	-30 / +40		
		[dBA]												
H1	H40CC	2,89	3,47	46,0				37,1			62,1			
	H50CS	3,86	4,63				47,8			38,9			63,9	
	H75CC	3,86	4,63	46,5				37,6			62,6			
	H75CS	5,30	6,36				48,6			39,7			64,7	
	H100CC	5,30	6,36	48,3				39,4			64,4			
	H100CS	6,75	8,10				49,8			40,9			65,9	
	H150CC	6,75	8,10	49,2				40,3			65,3			
	H150CS	7,71	9,26				50,1			41,2			66,2	
	H180CC	7,71	9,26	49,6				40,7			65,7			
	H180CS	8,47	10,16				50,7			41,8			66,8	
	H200CC	8,47	10,16	49,8				40,9			65,9			
	H200CS	9,88	11,86				51,2			42,3			67,3	
	H220CC	9,88	11,86	50,0				41,1			66,1			
	H220CS	10,85	13,02				51,8			42,9			67,9	
	H250CC	10,85	13,02	51,9				43,0			68,0			
	H250CS	12,17	14,60		49,8	51,8		40,9	42,9		65,9		67,9	
H280CC	12,17	14,60	54,8	53,4	51,8	45,9	44,5	42,9	70,9	69,5		67,9		
H280SB	13,23	15,87		53,4	51,8		44,5	42,9		69,5		67,9		
H280CS	13,23	15,87		53,4	51,8		44,5	42,9		69,5		67,9		
H2	H290CS	14,74	17,69				51,9			43,0			68,0	
	H300CC	14,74	17,69			51,4	51,9		42,5	43,0			67,5	
	H300CS	15,94	19,13	50,9	51,4			42,0	42,5		67,0		67,5	
	H350CC	15,94	19,13	51,4	51,9			42,5	43,0		67,5		68,0	
	H350SB	17,53	21,04	51,4	51,9			42,5	43,0		67,5		68,0	
	H380CC	17,53	21,04				52,4			43,5			68,5	
	H380SB	19,53	23,43	52,9	52,4			44,0	43,5		69,0		68,5	
	H390CS	19,53	23,43				53,4			44,5			69,5	
	H392CS	23,31	27,97			53,9	54,4		45,0	45,5		70,0		70,5
	H32	H403CC	19,98	23,98				55,9			47,0			72,0
H403CS		22,83	27,40	54,4	55,4			45,5	46,5		70,5		71,5	
H503CC		22,83	27,40			54,9	55,9		46,0	47,0			71,0	
H503CS		26,44	31,73	55,9	57,4			47,0	48,5		72,0		73,5	
H743CC		26,44	31,73			55,9	57,4		47,0	48,5			72,0	
H35	H401CS	19,29	23,14			54,4	55,4		45,5	46,5			70,5	
	H451CC	19,29	23,14	55,4	56,4			46,5	47,5		71,5		72,5	
	H451CS	23,13	27,76			55,4	56,9		46,5	48,0			71,5	
	H551CC	23,13	27,76	55,9	56,9			47,0	48,0		72,0		73,0	
	H551CS	27,33	32,80			57,9	58,4		49,0	49,5			74,0	
	H701CC	27,33	32,80			58,4	58,9		49,5	50,0			74,5	
	H701CS	31,88	38,26	57,9	58,4			49,0	49,5	50,0	74,0		74,5	
	H751CC	31,88	38,26			58,9	59,4		50,0	50,5			75,0	
	H751CS	38,06	45,67	58,4	58,9			49,5	50,0	50,5	74,5		75,0	
	H801CC	38,06	45,67			59,9	59,9			51,0			76,0	
	H801CS	43,73	52,48	58,4	58,9			49,5	50,0	50,5	74,5		75,0	
H851CC	43,73	52,48			59,9	59,9			51,0			76,0		
H41	H851CS	42,81	51,38			58,9	60,4		50,0	51,5			75,0	
	H1001CC	42,81	51,38	58,9	58,9			50,0	50,0	51,5	75,0		75,0	
	H1001CS	48,82	58,58			60,9	61,4		52,0	52,5			77,0	
	H1501CC	48,82	58,58	60,4	60,9			51,5	52,0	52,5	76,5		77,5	
	H1501CS	56,87	68,25			61,9	62,6		53,0	53,7			78,0	
	H2001CC	56,87	68,25	61,4	61,9			52,5	53,0	53,7	77,5		78,0	
	H1601CS	63,76	76,51			62,9	63,4		54,0	54,5			79,0	
H2201CC	63,76	76,51	62,4	62,9			53,5	54,0	54,5	78,5		79,5		
H5	H2000CS	75,83	91,00			61,4	61,9		52,5	53,0			77,5	
	H2500CC	75,83	91,00	60,9	61,4			52,0	52,5	53,0	77,0		78,0	
	H2500CS	85,01	102,02			62,4	62,9		53,5	54,0			78,5	
	H3000CC	85,01	102,02	61,9	62,4			53,0	53,5	54,0	78,0		79,0	
	H2700CS	92,25	110,69			63,4	63,9		54,5	55,0			79,5	
	H3200CC	92,25	110,69	62,9	63,4			54,0	54,5	55,0	79,0		80,0	
	H2900CS	102,35	122,82			64,4	64,9		55,5	56,0			80,5	
	H3400CC	102,35	122,82	63,9	64,4			55,0	55,5	56,0	80,0		81,0	
H6	H3000CS	113,74	136,49			65,4	65,9		56,5	57,0			81,5	
	H3500CC	113,74	136,49	64,9	65,4			56,0	56,5	57,0	81,0		82,0	
	H3500CS	127,52	153,02			65,9	66,4		57,0	57,5			82,0	
	H4000CC	127,52	153,02	65,4	65,9			56,5	57,0	57,5	81,5		82,5	
	H4000CS	138,37	166,04			66,4	66,9		57,5	58,0			82,5	
	H4500CC	138,37	166,04	65,9	66,4			57,0	57,5	58,0	82,0		83,0	
	H4500CS	153,52	184,22			66,5	67,0		57,6	58,1			82,6	
	H5000CC	153,52	184,22	66,0	66,5			57,1	57,6	58,1	82,1		83,1	
H7	H5000CS	164,30	197,16			66,9	67,4		58,0	58,5			83,0	
	H5500CC	164,30	197,16	66,4	66,9			57,5	58,0	58,5	82,5		83,5	
	H5500CS	184,19	221,03			67,1	67,6		58,2	58,7			83,2	
	H6000CC	184,19	221,03	66,6	67,1			57,7	58,2	58,7	82,7		83,7	
	H6000CS	199,86	239,83			67,3	67,8		58,4	58,9			83,4	
	H7500CC	199,86	239,83	66,8	67,3			57,9	58,4	58,9	82,9		83,9	
	H7501CS	221,75	266,10			67,4	67,9		58,5	59,0			83,5	
	H8001CC	221,75	266,10	66,9	67,4			58,0	58,5	59,0	83,0		84,0	
	H8000CS	244,78	293,74			67,5	68,0		58,6	59,1			83,6	
	H9000CC	244,78	293,74	67,0	67,5			58,1	58,6	59,1	83,1		84,1	

Gli eccellenti risultati ottenuti dalla Dorin sono stati anche "certificati" da strette misurazioni intensimetriche fatte dall'Università di Firenze secondo le norme ISO 9614-1 grado 2. La formula per ottenere la pressione sonora (Lp) ad una certa distanza (d), conoscendo la potenza sonora (Lw) è: $L_p = L_w + 10 \log [K / (4\pi x d^2)]$ dove K = Direttività = 1 per campo libero; d = Distanza in metri.

Strict intensimetric measurements made by the Florence University according to the rules ISO 9614-1 grade 2, "certified" the excellent results obtained by Dorin. The relation to obtain the sound pressure (Lp) at a certain distance (d), knowing the sound power (Lw), is: $L_p = L_w + 10 \log [K / (4\pi x d^2)]$ where K = Directivity = 1 for free field; d = Distance in meter.

L'Université de Florence a effectué, selon les règles ISO 9614-1 niveau, 2, des mesures précises et a "certifié" les excellents résultats obtenus par Dorin. L'équation pour obtenir le niveau de pression (Lp) à une certaine distance (d) si l'on connaît le niveau de puissance (Lw) est: $L_p = L_w + 10 \log [K / (4\pi x d^2)]$ où K = coefficient de résonance (1 pour champ libre); d = distance en mètres.

Die ausgezeichneten Ergebnisse bei Dorin wurden durch genaue Messungen der Leistungsdaten an der Universität Firenze gemäß ISO 9614-1, Stufe 2, "zertifiziert". Die Formel zur Berechnung des Schalldrucks (Lp) bei einer gegebenen Entfernung (d) und bekannter Schalleistung (Lw) lautet: $L_p = L_w + 10 \log [K / (4\pi x d^2)]$, wobei K = Richtwirkung = 1 für freies Feld; d = Entfernung in Metern.

R134a

Serie Range Serie Serie	Modello Model Modèle Typ	Temp. Cond. Cond. Temp. Temp. Cond. Kond. Temp.	Temp. [°C]	Q [W]	Capacità frigorifera Refrigerating capacity Puissance frigorifique Kälteleistung				P [kW]	Potenza assorbita Power input Puissance absorbée Leistungsaufnahme				
					Temperatura evaporazione / Evaporating temperature Température d'évaporation / Verdampfungstemperatur [°C]									
					+20	+15	+10	+5		0	-5	-10	-15	-20
H41	H1501CC	35	Q		47550	39600	32660	26650	21480	17100	13410	10340		
			P		7,78	7,69	7,43	7,03	6,51	5,92	5,27	4,61		
	45	Q	50700	42500	35290	29010	23580	18920	14950	11600	8790			
		P	9,80	9,59	9,21	8,69	8,06	7,35	6,59	5,81	5,05			
	H1501CS	35	Q		45120	37410	30700	24920	19970	15790	12300			
			P		8,55	8,36	7,96	7,39	6,71	5,98	5,23			
	45	Q		39980	33030	27000	21800	17360	13590	10420				
		P		10,28	9,70	8,96	8,13	7,25	6,36	5,53				
	H2001CC	35	Q		56220	46730	38440	31260	25110	19880	15500	11880		
			P		9,23	9,06	8,71	8,19	7,55	6,81	6,03	5,22		
	45	Q	59620	49880	41320	33870	27430	21910	17230	13290	10020			
		P	11,52	11,23	10,75	10,10	9,33	8,47	7,55	6,62	5,69			
H1601CS	35	Q		51150	42340	34670	28060	22410	17630	13640				
		P		9,72	9,37	8,83	8,15	7,39	6,60	5,83				
45	Q		45290	37350	30450	24500	19420	15110	11490					
	P		11,59	10,84	9,95	8,99	8,01	7,07	6,22					
H2201CC	35	Q		61570	51280	42300	34510	27830	22160	17390	13430			
		P		9,91	9,64	9,21	8,65	8,00	7,28	6,52	5,76			
45	Q	65770	55140	45800	37650	30610	24570	19430	15090	11460				
	P	12,51	12,02	11,38	10,63	9,79	8,90	7,98	7,07	6,19				
H5	H2000CS	35	Q		63080	51750	41930	33510	26320	20250	15130			
			P		10,13	9,90	9,48	8,90	8,17	7,33	6,41			
	45	Q		55490	45260	36450	28910	22510	17100	12560				
		P		12,13	11,57	10,82	9,93	8,93	7,83	6,67				
	H2500CC	35	Q		76060	63130	51840	42060	33670	26530	20530	15530		
			P		10,15	10,18	9,96	9,54	8,94	8,22	7,40	6,52		
	45	Q	80330	67060	55440	45320	36590	29110	22770	17420	12950			
		P	12,97	12,78	12,36	11,72	10,92	9,99	8,96	7,87	6,76			
	H2500CS	35	Q		69800	57720	47250	38230	30510	23930	18350			
			P		11,62	11,34	10,86	10,20	9,39	8,45	7,41			
	45	Q		61470	50700	41390	33380	26510	20650	15640				
		P		13,87	13,25	12,42	11,44	10,32	9,09	7,78				
H3000CC	35	Q		86050	71380	58610	47580	38140	30140	23430	17850			
		P		11,78	11,73	11,43	10,91	10,22	9,39	8,47	7,48			
45	Q	90750	75790	62700	51340	41560	33200	26110	20150	15150				
	P	15,05	14,76	14,23	13,47	12,55	11,49	10,32	9,10	7,86				
H2700CS	35	Q		76520	62770	50880	40680	32000	24660	18490				
		P		11,92	11,73	11,27	10,59	9,72	8,70	7,56				
45	Q		67360	54850	44090	34900	27120	20560	15050					
	P		14,54	13,85	12,94	11,83	10,57	9,17	7,69					
H3200CC	35	Q		91720	75940	62210	50350	40200	31600	24380	18380			
		P		11,93	12,05	11,84	11,37	10,67	9,81	8,82	7,75			
45	Q	97070	80800	66590	54260	43660	34610	26960	20550	15190				
	P	15,23	15,09	14,64	13,91	12,97	11,84	10,60	9,28	7,93				
H2900CS	35	Q		84880	69810	56780	45600	36090	28040	21280				
		P		13,67	13,37	12,80	12,01	11,02	9,89	8,65				
45	Q		74490	60900	49190	39180	30680	23500	17440					
	P		16,38	15,61	14,61	13,41	12,05	10,56	9,00					
H3400CC	35	Q		102660	85210	69960	56760	45440	35810	27710	20960			
		P		13,71	13,74	13,44	12,87	12,07	11,09	9,98	8,80			
45	Q	108420	90520	74820	61170	49380	39290	30730	23510	17480				
	P	17,50	17,25	16,68	15,82	14,74	13,48	12,09	10,62	9,13				
H6	H3000CS	35	Q		94330	77590	63110	50680	40110	31170	23650			
			P		15,19	14,86	14,23	13,34	12,25	10,99	9,61			
	45	Q		82790	67680	54670	43540	34090	26110	19380				
		P		18,20	17,35	16,23	14,90	13,39	11,74	10,00				
	H3500CC	35	Q		114090	94690	77750	63090	50500	39790	30790	23290		
			P		15,23	15,27	14,94	14,30	13,41	12,32	11,09	9,78		
	45	Q	120490	100590	83160	67980	54880	43670	34150	26130	19430			
		P	19,45	19,18	18,54	17,59	16,38	14,98	13,44	11,81	10,14			
	H3500CS	35	Q		105700	87160	71130	57370	45660	35760	27420			
			P		17,92	17,44	16,64	15,57	14,30	12,87	11,34			
	45	Q		93030	76500	62260	50080	39710	30940	23510				
		P		21,46	20,40	19,06	17,50	15,79	13,96	12,10				

- Funzionamento a 50 Hz
- Per funzionamento a 60 Hz, moltiplicare la resa per 1,18
- Le prestazioni si basano sulla norma europea EN12900
- Non miscelare mai olii estere con olii differenti
- Frequency rate 50 Hz
- For 60 Hz operation, data to be multiplied by 1,18
- Performance data are based on European Standard EN12900
- Never mix ester oils with different oils
- Fonctionnement à 50 Hz
- Pour le fonctionnement à 60 Hz, multiplier le rendement par 1,18
- Les données de puissance se basent sur la norme européenne EN 12900
- Ne mélanger jamais ester huiles avec different huiles
- Frequenz 50 Hz
- Für 60 Hz-Betrieb ist die Leistung mit 1,18 zu multiplizieren
- Leistungswerte basieren auf der europäischen Norm EN 12900
- Niemals Esteröl mit anderen Ölen vermischen



Serie Range Serie Serie	Modello Model Modèle Typ	Temp. Cond. Cond. Temp. Temp. Cond. Kond. Temp. [°C]	Q [W]		Capacità frigorifera Refrigerating capacity Puissance frigorifique Kälteleistung					P [kW]		Potenza assorbita Power input Puissance absorbée Leistungsaufnahme		
			Temperatura evaporazione / Evaporating temperature Température d'évaporation / Verdampfungstemperatur [°C]											
			+10	+5	0	-5	-10	-15	-20	-25	-30	-35	-40	
H41	H1501CC	35	Q	63280	53720	45240	37750	31180	25460	20510	16260	12630	9550	6950
			P	12,39	12,31	12,00	11,49	10,81	9,99	9,07	8,07	7,03	5,98	4,95
	H1501CS	35	Q	53960	45520	38070	31540	25860	20940	16720	13110	10050	7460	5270
			P	15,06	14,48	13,71	12,80	11,78	10,67	9,51	8,32	7,14	6,01	4,94
	H2001CC	35	Q	73380	62220	52320	43600	35970	29340	23620	18720	14560	11040	8090
			P	14,59	14,25	13,71	13,01	12,18	11,24	10,22	9,14	8,04	6,94	5,86
	H1601CS	35	Q				43270	35790	29250	23580	18710	14550	11040	8090
			P				13,36	12,42	11,38	10,29	9,16	8,01	6,88	5,79
	H2201CC	35	Q	62170	52520	44010	36540	30030	24390	19530	15360	11800	8760	6140
			P	17,59	16,76	15,79	14,69	13,49	12,23	10,92	9,60	8,28	7,01	5,79
	H2000CS	35	Q				48100	39780	32520	26220	20810	16190	12290	9020
			P				15,01	13,95	12,79	11,56	10,30	9,02	7,76	6,55
H2500CC	35	Q	81880	69420	58370	48640	40120	32720	26330	20870	16220	12300	9000	
		P	15,71	15,88	15,62	14,99	14,08	12,94	11,66	10,31	8,95	7,65	6,50	
H2500CS	35	Q	69440	58660	49140	40790	33510	27200	21770	17110	13130	9730	6810	
		P	19,41	18,86	17,95	16,77	15,39	13,87	12,28	10,71	9,21	7,87	6,75	
H2500CC	45	Q				54810	45100	36610	29260	22940	17580	13070	9320	
		P				16,77	15,73	14,46	13,03	11,49	9,88	8,27	6,69	
H2500CS	45	Q				46340	37900	30560	24210	18780	14160	10270	7000	
		P				19,28	17,66	15,88	14,00	12,06	10,13	8,25	6,47	
H3000CC	35	Q	93560	78970	66060	54730	44830	36250	28860	22530	17140	12560	8660	
		P	17,27	17,31	16,97	16,30	15,35	14,18	12,84	11,38	9,86	8,32	6,83	
H3000CS	35	Q	78920	66360	55310	45650	37240	29960	23680	18280	13640	9620	6100	
		P	21,52	20,79	19,76	18,46	16,96	15,32	13,57	11,77	9,99	8,26	6,65	
H2700CS	35	Q				61250	50480	41070	32920	25920	19970	14970	10800	
		P				20,095	18,338	16,549	14,762	13,01	11,327	9,745	8,2986	
H3200CC	35	Q	104860	88660	74300	61650	50580	40950	32620	25470	19350	14130	9690	
		P	19,28	19,35	18,99	18,26	17,22	15,92	14,42	12,78	11,06	9,31	7,59	
H2900CS	35	Q	88510	74570	62260	51460	42030	33840	26750	20640	15360	10770	6760	
		P	24,02	23,25	22,12	20,69	19,03	17,20	15,24	13,22	11,19	9,22	7,36	
H3400CC	35	Q				68230	55990	45320	36090	28200	21530	15970	11410	
		P				20,78	19,08	17,33	15,54	13,72	11,90	10,07	8,26	
H3500CC	35	Q	114330	96730	81180	67520	55590	45260	36360	28740	22250	16730	12040	
		P	23,49	23,18	22,42	21,27	19,83	18,16	16,36	14,48	12,63	10,86	9,27	
H3400CS	35	Q	95000	80170	67130	55740	45830	37260	29870	23510	18030	13280	9100	
		P	28,00	26,80	25,26	23,45	21,46	19,37	17,24	15,16	13,22	11,48	10,03	
H3500CS	35	Q				75740	62130	50260	40000	31240	23830	17670	12610	
		P				23,01	21,16	19,23	17,24	15,22	13,18	11,14	9,14	
H3000CS	45	Q				64120	52290	42030	33200	25680	19350	14080	9750	
		P				25,53	23,19	20,80	18,39	15,97	13,58	11,22	8,92	
H3500CC	45	Q	126620	107320	90220	75150	61970	50500	40590	32080	24800	18600	13310	
		P	26,03	25,58	24,70	23,44	21,89	20,11	18,16	16,12	14,06	12,05	10,15	
H3500CS	45	Q	105340	89050	74700	62110	51120	41590	33340	26220	20070	14720	10010	
		P	30,82	29,50	27,84	25,91	23,78	21,52	19,21	16,90	14,67	12,58	10,72	
H3000CS	45	Q				81650	67300	54760	43880	34530	26540	19800	14140	
		P				25,84	24,21	22,28	20,11	17,79	15,38	12,94	10,55	
H3500CC	45	Q				69350	56860	45980	36560	28460	21550	15670	10680	
		P				29,73	27,19	24,45	21,58	18,65	15,72	12,86	10,16	
H3500CS	45	Q	136550	115310	96550	80070	65710	53270	42590	33460	25720	19190	13670	
		P	27,18	27,10	26,41	25,21	23,57	21,60	19,38	17,01	14,58	12,18	9,90	
H3500CS	45	Q	114790	96550	80510	66490	54320	43820	34800	27070	20470	14810	9900	
		P	33,83	32,51	30,69	28,48	25,96	23,22	20,37	17,48	14,65	11,97	9,54	
H3500CS	45	Q				92330	75970	61670	49280	38650	29600	21990	15660	
		P				29,11	26,89	24,47	21,91	19,27	16,60	13,95	11,39	
H3500CS	45	Q				77830	63640	51290	40630	31490	23710	17150	11640	
		P				33,37	30,13	26,82	23,47	20,14	16,89	13,78	10,86	

- Funzionamento a 50 Hz
- Per funzionamento a 60 Hz, moltiplicare la resa per 1,18
- Le prestazioni si basano sulla norma europea EN12900
- Non miscelare mai olii estere con olii differenti
- Frequency rate 50 Hz
- For 60 Hz operation, data to be multiplied by 1,18
- Performance data are based on European Standard EN12900
- Never mix ester oils with different oils
- Fonctionnement à 50 Hz
- Pour le fonctionnement à 60 Hz, multiplier le rendement par 1,18
- Les données de puissance se basent sur la norme européenne EN 12900
- Ne mélanger jamais ester huiles avec different huiles
- Frequenz 50 Hz
- Für 60 Hz-Betrieb ist die Leistung mit 1,18 zu multiplizieren
- Leistungswerte basieren auf der europäischen Norm EN 12900
- Niemals Esteröl mit anderen Ölen vermischen